



USER MANUAL

Mechanical Wireless Keyboard



PRODUCT BASIC

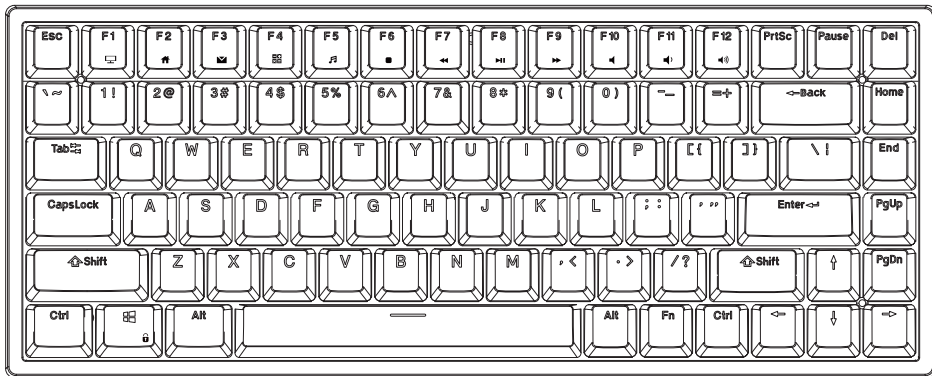

Keyboard

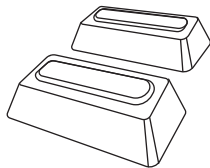

Pair Magnet Stands

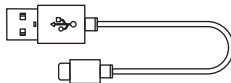

Type-C Cable



User Manual

WIRED MODE & CHARGING

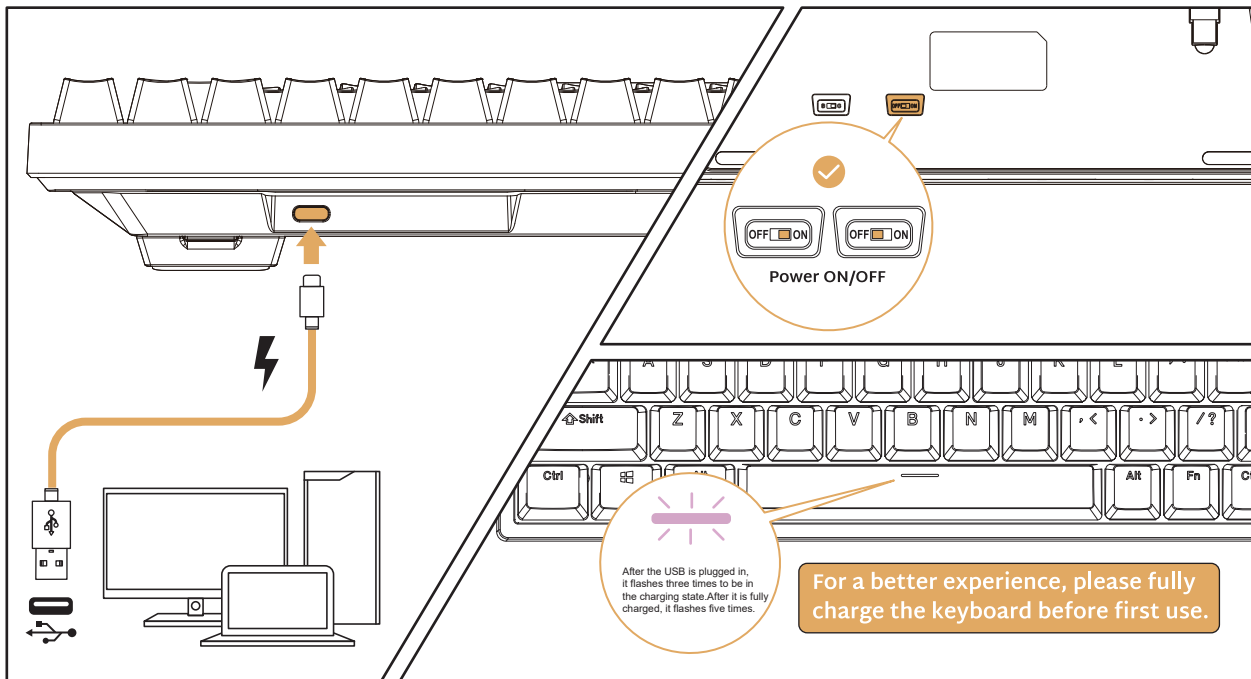

HOW TO USE

BT Connection

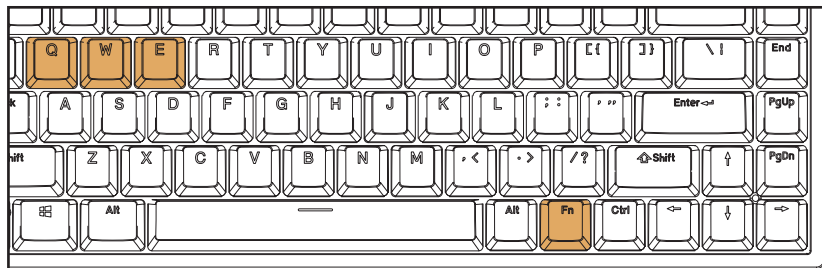
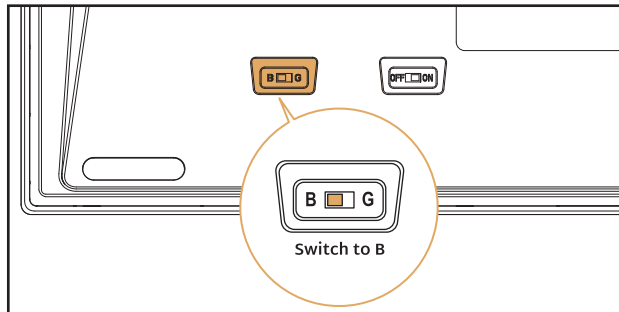
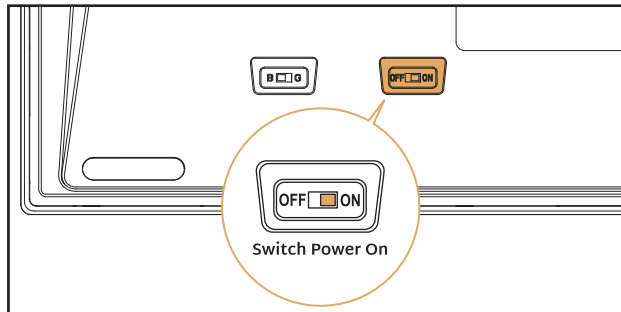

1 SHORT PRESS
Fn+Q/W/E/ to BT Channel

2 LONG PRESS
Fn+Q/W/E/ Entry Pairing Mode



HOW TO USE

2.4Ghz

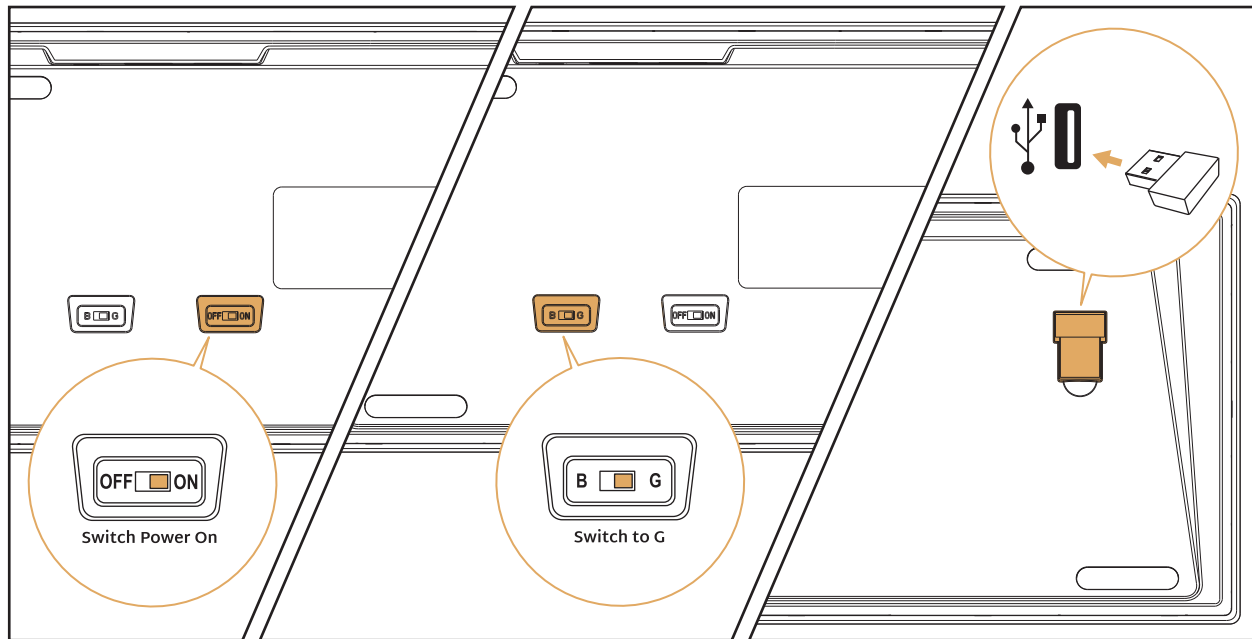

BACKLIGHT CONTROL

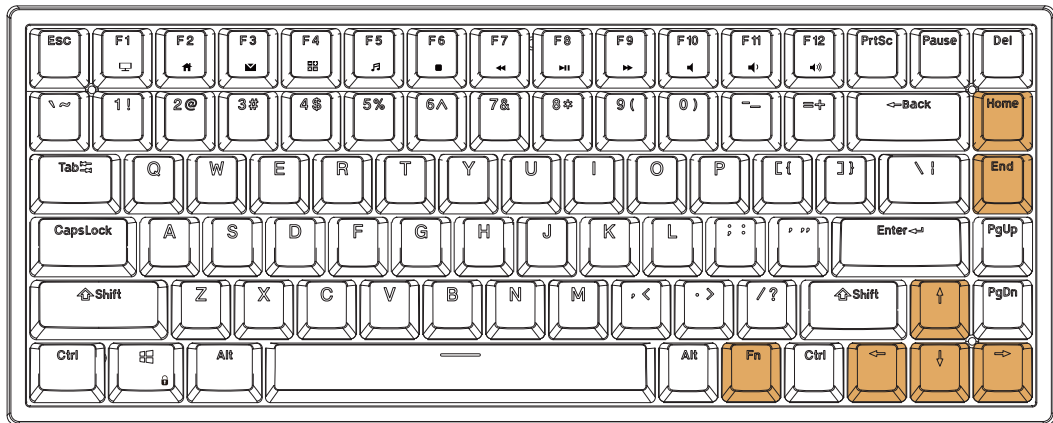

Switch Backlight Mode



Backlight Brightness +



Backlight Brightness -

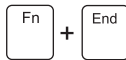

Switch Backlight Color

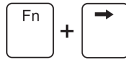

Backlight Speed +



Backlight Speed -

MULTIMEDIA KEY FOR WINODWS

Windows System **FN + A**: switch to Windows system

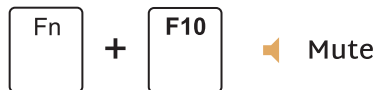
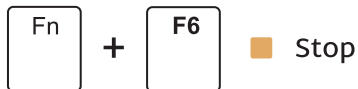
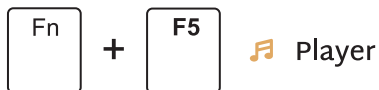

MULTIMEDIA KEY FOR MAC

MAC System **FN + S**: switch to MAC system



SYSTEM REQUIREMENTS

BT Mode

- **Device With Bluetooth 3.0 or later**
- **PC:** Windows 7 or Later
- **Mac:** macOS X 10.6 Snow Leopard or Later
- **iOS:** All iPads/iPhone 5 or Later
- **Android:** 5.0 Lollipop or Later

Wired/2.4Ghz Mode

- **Computer With Available USB port**
- **PC:** Windows 7 or Later
- **Mac:** macOS X 10.6 Snow Leopard or Later

In wireless state, the backlight will not be operated for 5 minutes to sleep. In wired mode, the backlight goes into sleep after 5 minutes without operation

Have an issue with one of our RK products?

Feel free to contact us with any product issues or questions.
We will reply as quickly as possible to ensure all your needs are handled.
Please contact the seller

